

# Data Sheet



Article number: 604133030055

Description: Taper bored timing belt pulley  
HTD 30 14M 55 TL 2517

## Measures

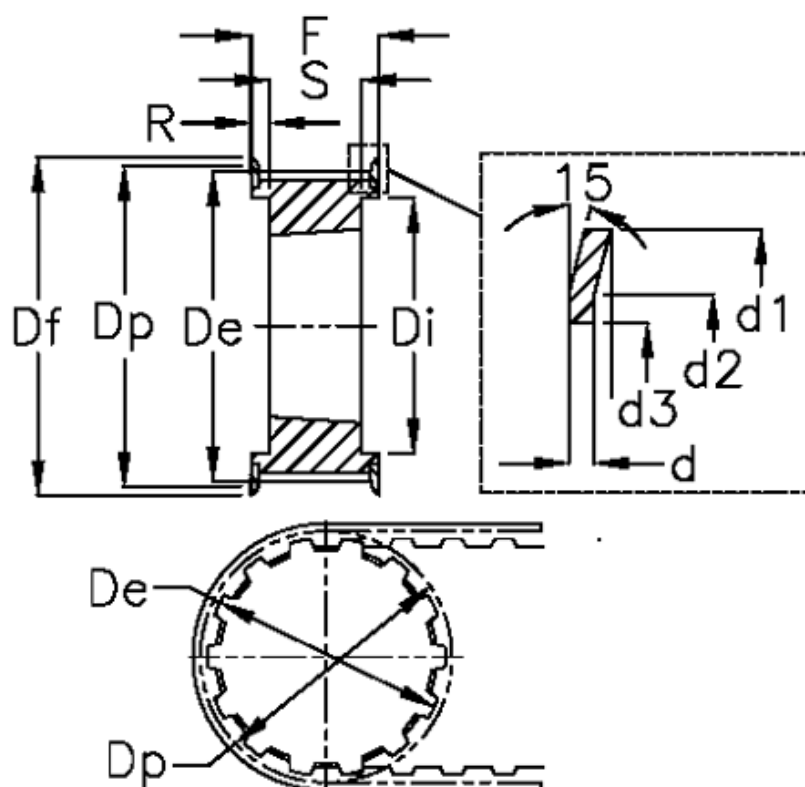

d = 2.5	F = 70	Weight = 2.7
d1 = 138	Flange type = F43	Width = 55
d2 = 132	For bushing = 2517	
d3 = 121	Max bore = 60	
De = 130.99	r = 12.5	
Df = 138	S = 45	
Di = 100	Tooth number = 30	
Dp = 133.69	Type = 14M	